

MODEL RS 838

UNDERMOUNT TYPE

GENERAL

Fine quality sink bowl formed of 16 gauge
BA 304 18/10 nickel bearing stainless steel.

DESIGN FEATURES

Bowl Depth : 10"
Finish : Soft Satin Finish
Underside : Sound absorbing pads and special paint
applied to dampen sound
Drain Opening : 3-1/2"



OPTIONAL ACCESSORIES

Stainless Steel Bottom Grid
Wood Cutting Board
Glass Cutting Board
Stainless Steel Colander
Drying Rack

SINK DIMENSIONS (INCHES)

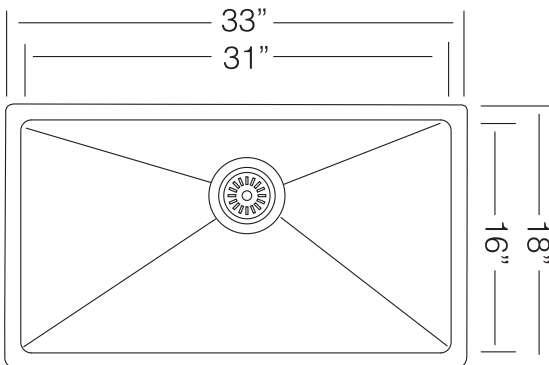

Recommended Cabinet Size 36"

INSTALLATION PROFILE*

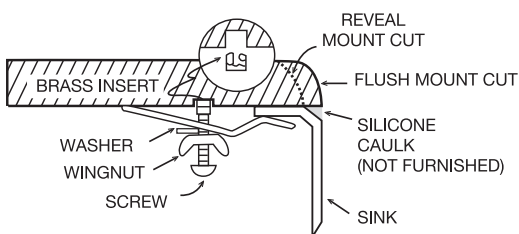

*Template and countertop mounting clips are packed with every sink

Ukinox reserves the right to change product specifications without notice.
Printed in USA © 2019 Ukinox

